

ROTATOR GR104DB

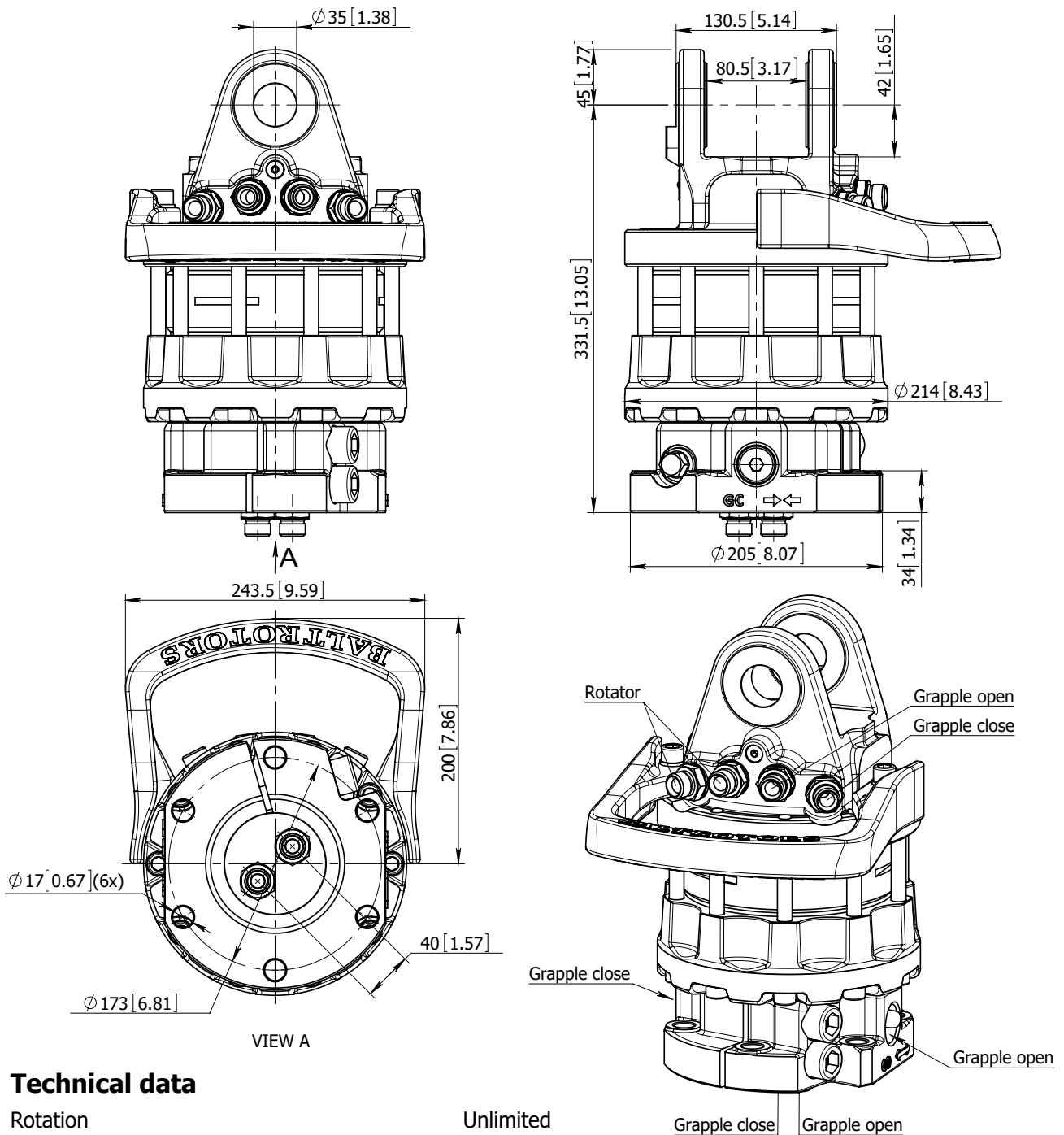

Technical data

Rotation	Unlimited
Max axial load static, KN (lbf)	+100 (22485) - 80 (17985)
Max axial load dynamic, KN (lbf)	+50 (11242) - 40 (8992)
Torque at 25Mpa (3625psi), Nm (lb ft)	2500 (1844)
Rec oilflow, l/min (US gallon)	25 (6.6)
Weight, kg (lb)	58 (128)

Max working pressure:

Rotator	←R→	Max 25 MPa (3625 psi)	G 1/2
Grapple / Tool open	←G→	Max 30 MPa (4350 psi)	G 1/2
Grapple / Tool close	→G←	Max 30 MPa (4350 psi)	G 1/2

Connection: